

Starling — model H0440

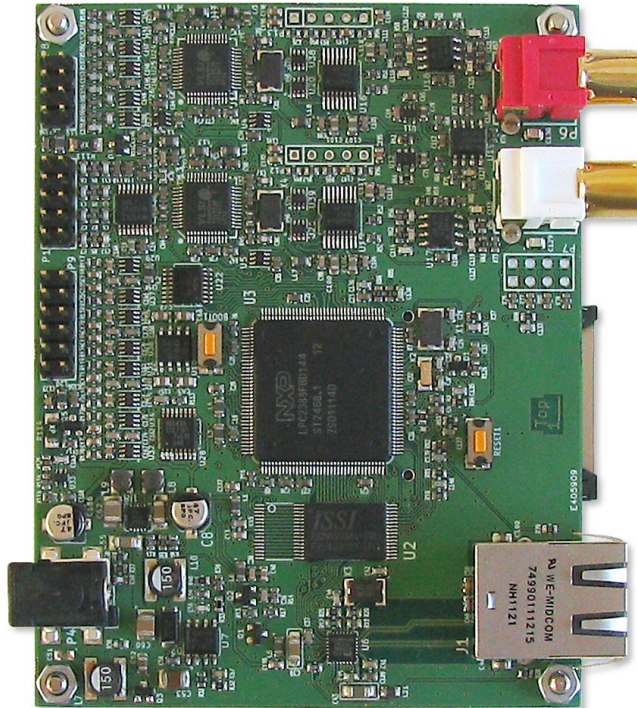

ITB CompuPhase

telephone: +31 (0)35 6939261

Eerste Industriestraat 19-21

fax: +31 (0)35 6939293

1401 VL Bussum

email: info@compuphase.com

The Netherlands

The Starling audio controller/player model H0440 is a solid-state programmable controller equipped with a dual digital audio decoder and interfaces for auxiliary peripherals and/or connectivity.

Features

- Double decoder for MP3, Ogg Vorbis and uncompressed PCM; AAC on request.
- Integrated DACs for cross-mixing and cross-fading.
- Volume and tone control; VU-meter for measuring the audio volume of each DAC.
- Wide range input power: 7.5 V to 28 V DC.
- SD/MMC card support for content (audio and user programs), including support for SD-HC.
- Ethernet interface, 10/100 Mbit/s, auto-negotiation.
- Two RS232 ports, one SPI port with two general-purpose “slave select” lines.
- Eight general-purpose I/O pins with configurable logical voltage, one analogue output. A debounce filter can be configured for each pin, to optionally de-
- bounce switch or relay contacts.
- Temperature sensor.
- Real-time clock with backup battery.
- One general-purpose switch, two general-purpose LEDs.
- User programmable in the PAWN programming language.
- Optional digital audio output (I²S interfaces).
- Optional strong encryption (128-bit key) of the audio content.
- 72MHz ARM CPU with 512 KiB RAM.
- Designed for industrial temperature range (-40 °C to +85 °C).



Specifications

Absolute maximum ratings

Operating voltage.....-0.3 V to +28 V.
Input voltage on I/O pins.....-0.5 V to +6.5 V.

General

Operating voltage.....+7.5 V DC to +28 V DC.
Current consumption.....at 7.5 V: 180 mA when idle (card inserted); 190 mA when playing audio (both decoders); 210 mA with network active (streaming).
At 12 V: 115mA when idle (card inserted); 125 mA when playing audio (both decoders); 130 mA with network active (streaming).

Audio

Supported formats.....MPEG layer III ("MP3") for MPEG versions 1, 2 & 2.5;
Ogg Vorbis, floor 1; RIFF WAV (8-bit & 16-bit), including A-Law, μ -Law and IMA ADPCM; MIDI format 0;
AAC-LC(+PNS) & HE-AAC level 3 (SBR+PS); **AAC support requires a license.**
Frequency response.....20 Hz to 20 kHz, ± 0.5 dB.
Dynamic range.....90 dB (typical).
Distortion+Noise.....THD+N < 0.03% at 1 kHz +0 dBu.
Noise.....SNR 93 dB at 1kHz +0 dBu (typical).
Output impedance.....100 Ω .
Max. output level.....+6 dBu (European studio level).

Integrated peripherals

Temperature sensor.....Measures -40 °C to +125 °C; typical accuracy 0.5 °C.
Real-time clock.....Inaccuracy < ± 1.7 seconds per 24 hours.
Pseudo-random numbers.....Cryptographic strength, cycle length 2^{32} , initialized from a true random seed.
RS232 interfaces.....Two interfaces conforming to 3-wire RS232 ports; standard signal levels.
SPI interface.....Standard SPI interface, with programmable voltage level and two slave select lines
Network.....10/100 Mbit/s, full/half-duplex with auto-negotiation.
Digital I/O.....8 general-purpose I/O pins, with programmable voltage level (2.5 V to 5.0 V); max. 50 mA source or sink; all pins are ESD/EMC filtered.
Analogue out.....1 software-controlled analogue output pin.

Mechanical

Dimensions.....100 mm \times 80 mm.
Maximum height above PCB....14 mm (RJ45 connector).
Maximum height below PCB....5.4 mm (battery connector).
PCB thickness.....1.6 mm.
Weight.....0.070 kg.
Mounting holes.....Four mounting holes $\varnothing 3$ mm spaced 93 mm horizontally and 73 mm vertically. The holes are *not* electrically connected to PCB ground.
See also *Drawings* on page 7.

Operating conditions

Temperature.....Designed for -40 °C to +85 °C.
 Humidity.....5% to 95% non-condensing.
 Vibration.....Full solid-state device, no moving parts.

Conformity

EMC (emission/immunity).....Compliant with EU Directive 2004/108/EC: EN 55022 and EN 55024 + A1 (2001) + A2 (2003).
 Electrical safety.....Compliant with EU Directive 2006/95/EC: EN 60950-21
 RoHS.....Compliant with EU Directive 2002/95/EC.

Interface specifications

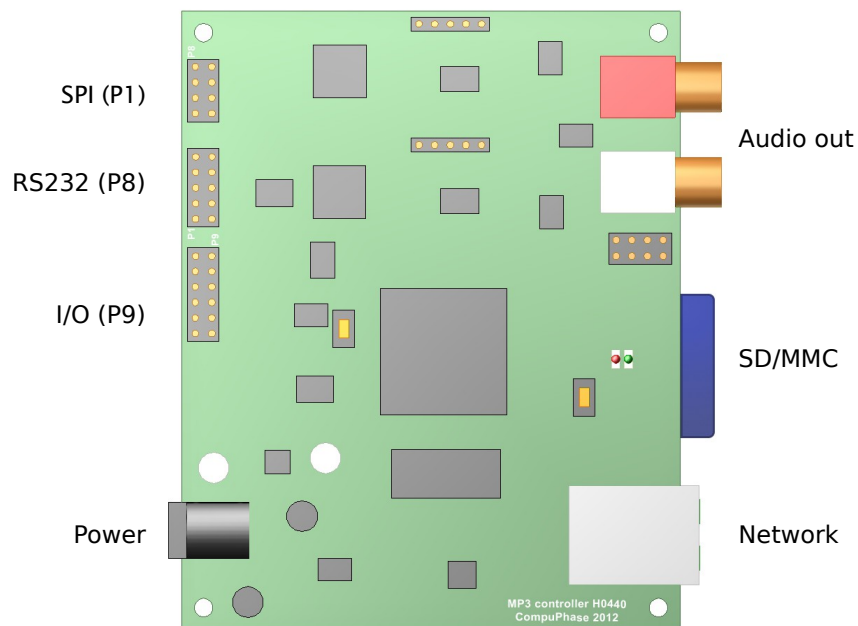

The power connector

The Starling needs DC voltage in the range of 7.5 V to 28 V. The DC power connector specifications are outer diameter Ø5.5 mm, pin diameter Ø2.1 mm. The (centre) pin is the positive pole.



Audio connectors

The Starling model H0440 has two RCA connectors (“phono” sockets) for standard “line-level” outputs. One of these RCA connectors has a red ring, the other is either white or black (depending on the series). The red connector is for the right channel, the white/black for the left channel.

Optionally, the analogue audio is also available from pin header P7. The pin header has the audio signal of both audio decoders separately, plus the mixed channels.

The pin lay-out of P7 is:

	1	Left channel, decoder 1	2	Left channel, mixed
	3	Right channel, decoder 1	4	GND ground
	5	Left channel, decoder 2	6	Right channel, mixed
	7	Right channel, decoder 2	8	GND ground

Network connector

An RJ-45 connector for a 10Base-T/100Base-T IEEE 802.3 compliant Ethernet interface, with auto-negotiation to select the link-up speed (10/100 Mbps) and full/half duplex. Two LEDs indicate link and activity status.

A unique MAC address is pre-programmed in each device.

SD/MMC memory card

The Starling is equipped with a push/push SD/MMC card connector. When a card is inserted, it exceeds the edge of the Starling circuit board by approximately 7 mm.

Both SD memory cards and MMC memory cards (of the standard format) are accepted. Both the original format and the "high capacity" formats (SD-HC cards) are supported. SD-XC cards are supported after re-formatting them with a standard FAT file system.

The SD/MMC memory card must hold all the audio tracks and the user programs ("scripts").

Real-Time clock (battery backup)

A real-time clock for keeping the time is integrated. A CR2032 battery needs to be installed for the real-time clock to keep running without main input power.

The real-time clock is based on a quartz crystal oscillator with an inaccuracy of maximum 1.7 seconds deviation per 24 hours, at room temperature. The oscillator is not temperature-compensated.

When no battery is present, the device resets to 00:00 hours at 1 January 1970 after losing power.

RS232 (serial communication)

Two serial ports are provided on a 5×2 pin header marked P1. The signals on these pins have the standard voltage RS232 levels for serial communication. The pin lay-out has been chosen so that the Rx/D and Tx/D pins for the first port match with a IDC D-subminiature socket pressed on ribbon wire, were the Rx/D and Tx/D lines for the second port get mapped to the DTR and DSR lines.

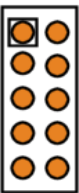
	1	N.C. not connected	2	TxD2 Transmit, port 2 / DTR
	3	TxD1 Transmit, port 1	4	N.C. not connected
	5	RxD1 Receive, port 1	6	N.C. not connected
	7	RxD2 Receive, port 2 / DSR	8	N.C. not connected
	9	GND ground	10	GND ground

All common Baud rates are supported (1200, 2400, 4800, 9600, 19200, 28800, 38400, 57600 or 115200); special Baud rates, such as 31250 for MIDI, are supported as well. The number of data bits and stop bits, and the parity is configurable in the user program.

The RS232 interface supports the XON/XOFF protocol (software handshaking), but no hardware handshaking protocols. The use of a handshaking protocol is configurable.

SPI (serial communication)

The 4×2 pin header marked P8 provides a general purpose SPI communication port with two “slave select” signals. In addition, an output power pin is provided on this connector; this power output pin must be enabled by the script, it is disabled by default.

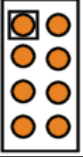
	1	MOSI	master-out/slave-in	2	SSEL1	slave select 1
	3	SSEL0	slave select 0	4	MISO	master-in/slave-out
	5	SCK	SPI clock (max. 8 MHz)	6	GND	ground
	7	V _{EXT}	power (fused at 400 mA)	8	GND	ground

The voltage levels of the SPI signal pins is the configurable *external voltage*, which is 3.3 V by default. The maximum SPI clock frequency is 8 MHz.

The voltage of the power output pin (if enabled) is also the *external voltage*. The power output has a self-resetting fuse for short-circuit protection. The maximum current that can be drawn from the power pin is (V_{EXT}) 400 mA.

General purpose I/O

The 6×2 pin header marked P9 has 8 general purpose digital pins for communicating with other devices that can be configured as input or output, and one analogue output-only pin. In addition, an output power pin is provided on this connector; this power output pin must be enabled by the script, it is disabled by default.

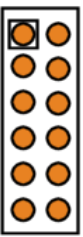
	1	IO0	general purpose I/O	2	IO1	general purpose I/O
	3	IO2	general purpose I/O	4	IO3	general purpose I/O
	5	IO4	general purpose I/O	6	IO5	general purpose I/O
	7	IO6	general purpose I/O	8	IO7	general purpose I/O
	9	A _{OUT}	analogue out	10	GND	ground
	11	V _{EXT}	power (fused at 400mA)	12	GND	ground

The I/O pins are EMC and ESD filtered, and slew-rate limited to 1 MHz. The analogue output pin is limited to 100 kHz.

When the I/O pins are configured as inputs, the pins are 5 V-tolerant. Each pin has a pull-up resistor of 10 kΩ.

When the I/O pins are configured as outputs, the high-level voltage for the pins is the configurable *external voltage*, which is 3.3 V by default. The analogue output pin has a range from 0 V to the *external voltage*.

Each output pin has a series resistor of 120Ω for current limiting and short-circuit protection. The output current drawn from a pin should not exceed 24mA. The output pins can directly drive a LED (or a similar load, such as an opto-coupler), usually without requiring an *external* current-limiting resistor. The current limit depends on the forward voltage of the LED and the configured voltage of the output pins. At the default pin voltage of 3.3 V and a green LED with a typical forward voltage of 2.1 V, the current is:

$$I = \frac{V_{ext} - V_F}{R_{limit}} = \frac{3.3 - 2.1}{120} = 10 \text{ mA}$$

The analogue output has a series resistor of 220Ω for current limiting and short-circuit protection.

The voltage of the power output pin (if enabled) is the *external voltage*. The power output has a self-resetting fuse for short-circuit protection. The maximum current that can be drawn from the power pin (V_{EXT}) is 400 mA. Note that the power pin is disabled by default.

I²S audio output

In addition to analogue output on the RCA connectors, the Starling model H0440 can provide the audio in I²S format, for an external DAC. The I²S signals are provided on two 1×5 pin headers, one for each decoder. Logic levels for all pins is 3.3V CMOS.

	1	BCLK	bit clock (sample clock), 1.536 MHz (32×Fs)
	2	DATA	serial data output bits
	3	MCLK	master clock, 12.288 MHz (256×Fs)
	4	LR _{OUT}	left/right word clock, 48 kHz (Fs)
	5	GND	ground

Digital audio resolution is 16-bit. The I²S “SDATA” line has 32-bits per frame, 16-bits for the left channel and 16-bits for the right channel. No padding or zero-filling occurs. Suitable audio DACs are the Wolfson WM8741 and the Burr-Brown PCM1780 series.

Temperature sensor

The temperature sensor has a range of -40 °C to +125 °C, with a precision of 0.5 °C and an accuracy of ±2 °C. The temperature can be read using the Pawn scripting language.

Note that although the temperature sensor measures temperatures up to +125 °C, temperatures above +85 °C are outside the specifications for the operating conditions of the Starling.

General-purpose switch

The Starling model H0440 has two “push-button” switches on the circuit board, marked `RESET` and `FUNC`. The switch marked `RESET` always resets the device, this cannot be reprogrammed. The switch marked `FUNC` has a special operation during device diagnostics, but it can also be used from within a user program.

General-purpose LEDs

The Starling has two general-purpose LEDs, one red, one green. The default function of the green LED is to indicate power, while the red LED blinks during access of the SD/MMC card. A user program can change the functionality of the LEDs.

User program

The script controls the operation of the Starling and its peripherals. The script is written in the PAWN language and it is stored (in compiled form) on the SD/MMC card. Version 4.0 (or later) of the PAWN toolkit is required for the Starling. Full information on the PAWN language can be found on the company web site: <http://www.compuphase.com/pawn/>.

Drawings

